



Australian Government



bragg
institute

ansto in partnership

Australian Nuclear Science & Technology Organisation

Recent sample environment innovations for SANS & update on the OPAL reactor

5th International Workshop on Sample Environments
in Neutron Scattering Facilities,
Villard De Lans, France, May 25-28 2008.

S Olsen, S Pullen, M Perry, G Davidson,
E Gilbert, F Klose, J Schulz, R Robinson

Overview of the talk

1. Current situation at the OPAL reactor.
2. 5 Tesla Horizontal Field High Temperature Superconducting Magnet for SANS and Reflectometry.
3. Rapid Heat and Quench Cell for SANS
4. Other SANS SE procurements
 - 11 Tesla Horizontal magnet. (Out to tender)
 - Stopped Flow mixing cell (Order placed)
 - 10 & 20 position sample changers (NIST design)
5. Robotic Sample Changer for Powder Diffractometry.
6. In Situ Reaction Chamber (Controlled Gas Furnace)
7. SE equipment based on designs at other facilities:
 - NIST Gas Dosing Rig
 - ISIS Reflectometry 5 sample liquid – air trough
 - (Late 2008) ILL low temperature Paris-Edinburgh Cell design

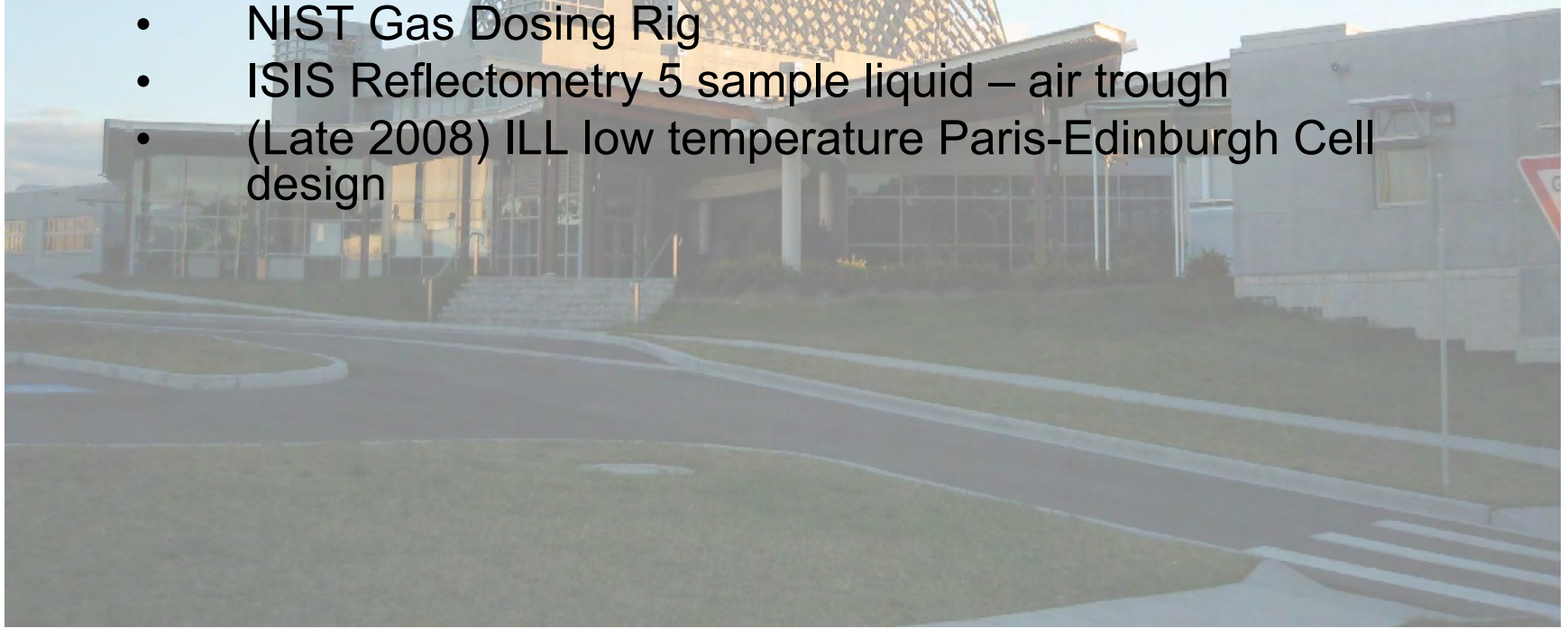



Australian Government

Ansto

Current situation with the OPAL Reactor

- 20MW light water reactor, first criticality Aug 06, full power Nov 06.
- 20 Litre Liquid Deuterium Cold Neutron Source.
- Shut down 24-Jul-07 due to displacement of some of the fuel rods.
- It took 5 months to find the root cause and 4 more for regulatory approval. Restarted 2-May-08.
- HRPD & HIPD commissioned prior to shutdown. A handful of 'friendly user' experiments were completed.
- During shutdown main SE activities were design and procurement.



**ANCILLARIES
STRATEGIC
PLAN**

Where is the reactor?

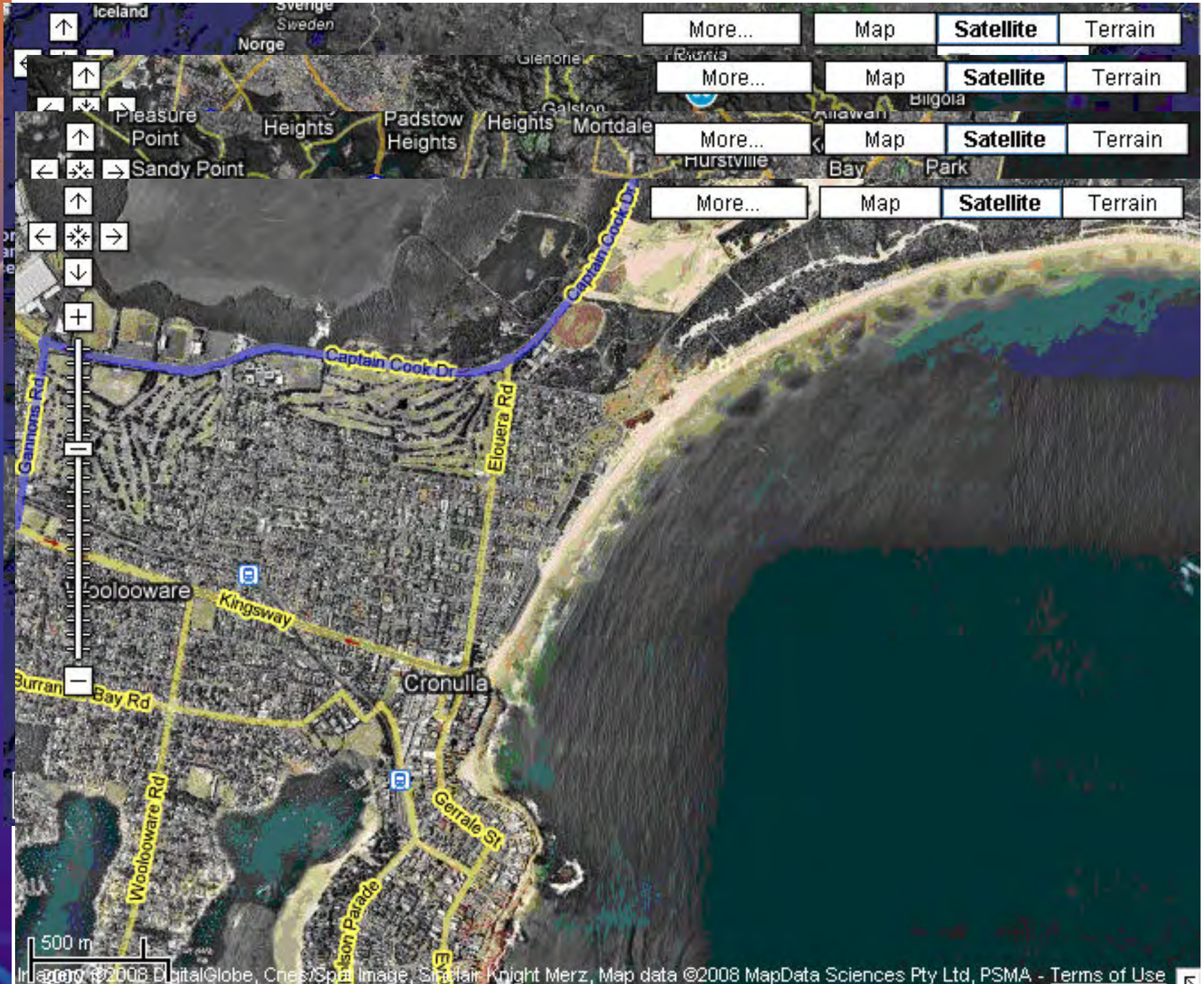

ANCILLARIES
STRATEGIC
PLAN

Instruments in the Neutron Guide Hall

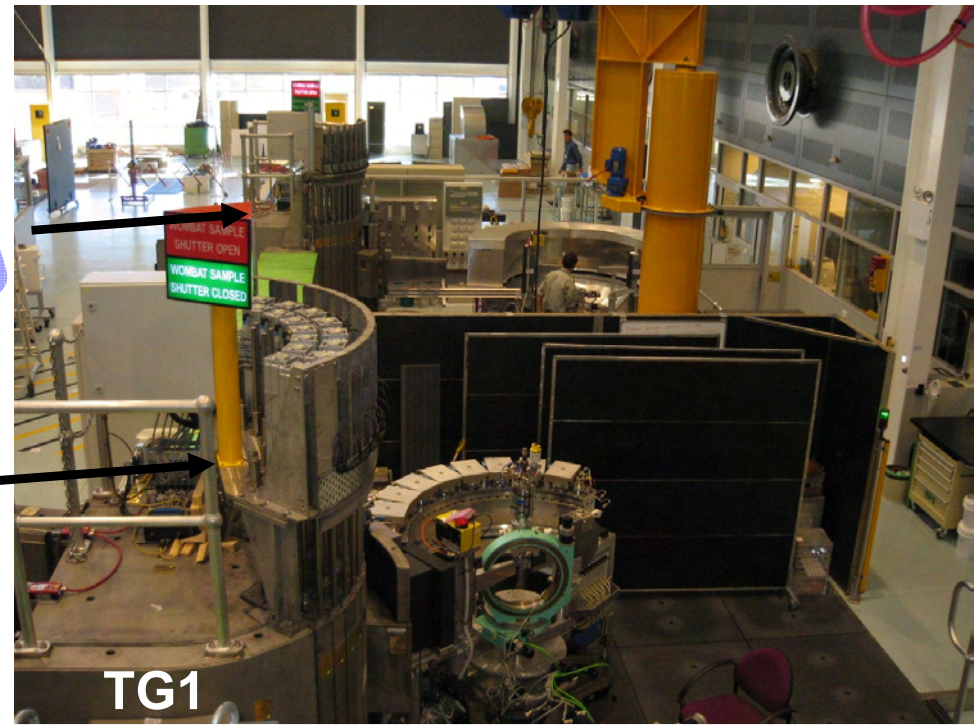
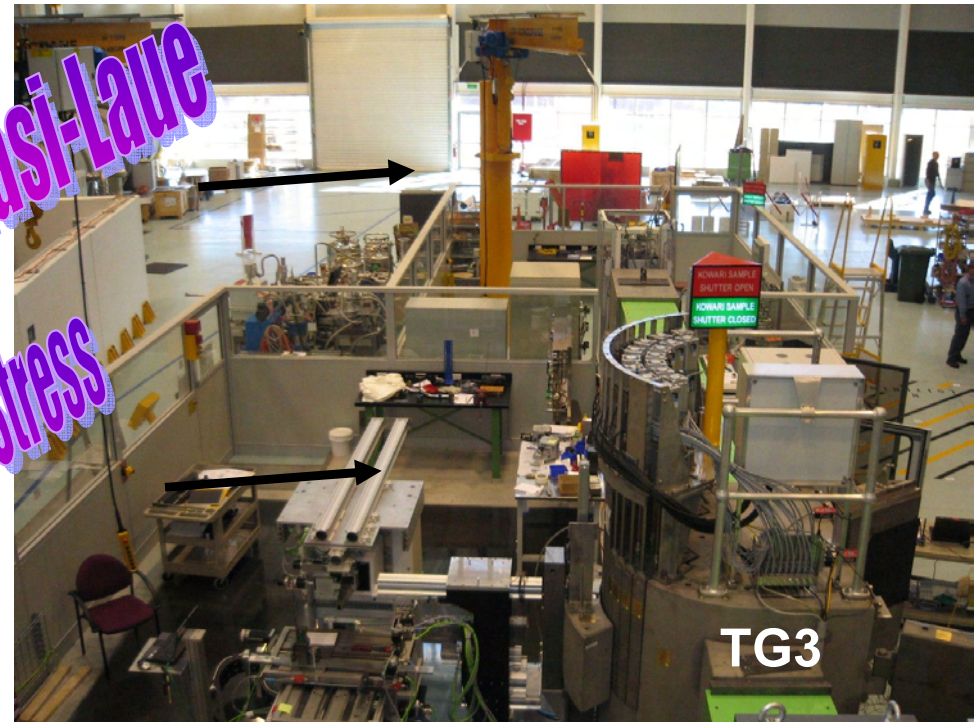

Under Construction

- Time of flight Polarisation Analysis Spectrometer
- USANS

Reactor face, & neutron guides

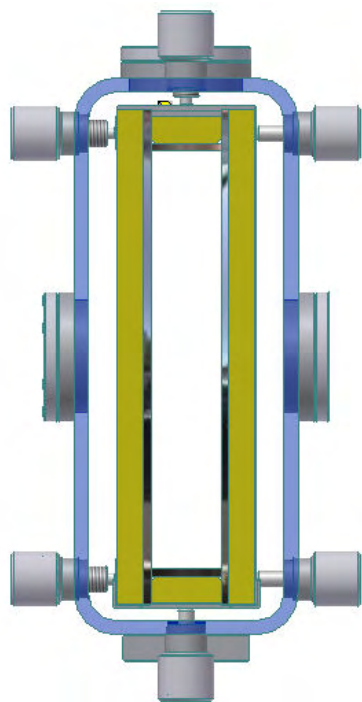

neutron guide cross-section

Beams vary from 50 - 100 mm wide and from 150 - 300 mm high at exit window

ANCILLARIES
STRATEGIC
PLAN

The National Science Council of Taiwan is funding the cold triple-axis Spectrometer.

Cold TAS
Under Construction

Thermal TAS



Australian Government

Ansto

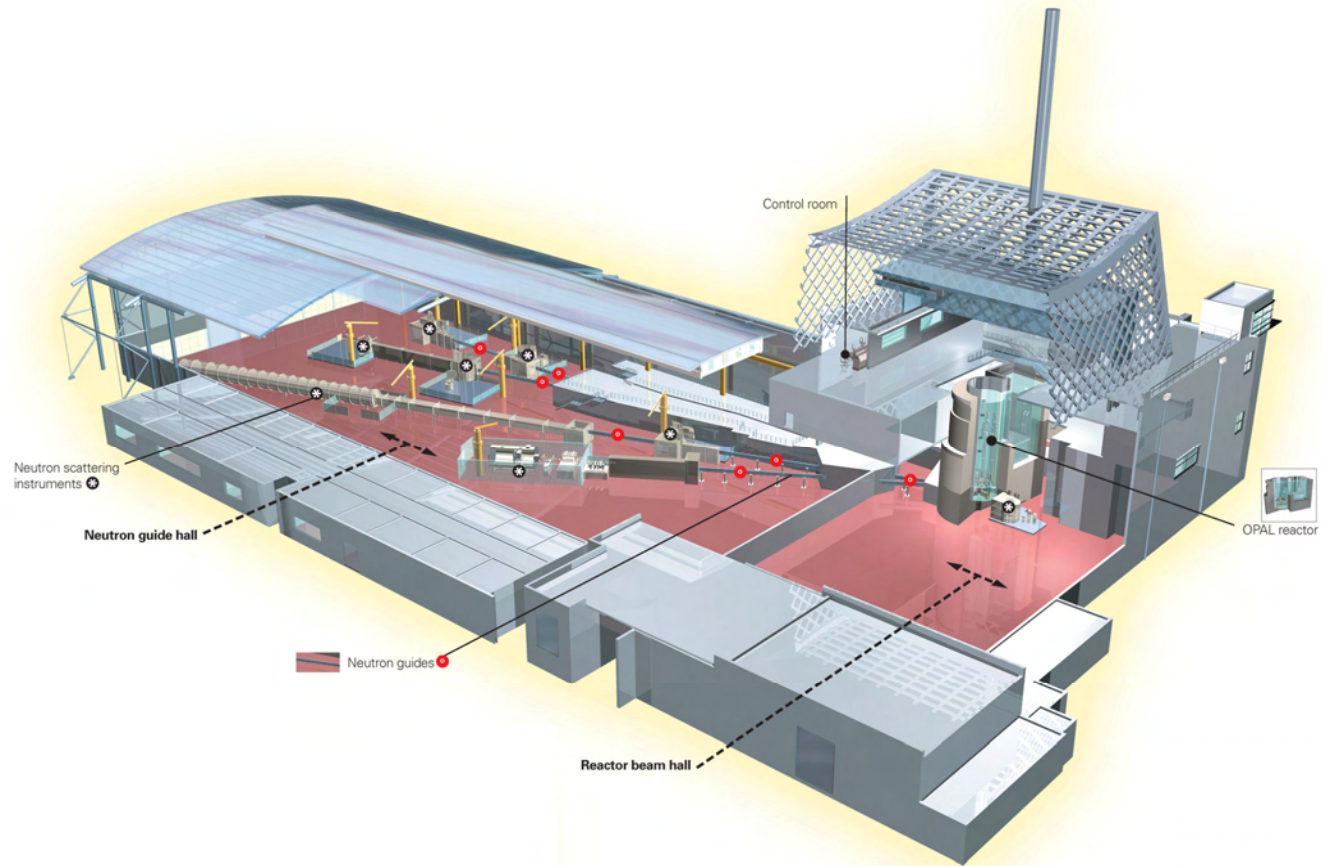

Sample Environment Group

- Currently have 3 full time and one contractor.
- Require a software programmer.
- Interfacing via SICS (PSI)
- Reviewing options for graphical interfacing – between SEA (PSI) LabView (eg SNS/TUDeft) and an inhouse design (GumTree).

ANCILLARIES
STRATEGIC
PLAN

Sample Environment Team



Scott Olsen – Engineer,
Team Leader



Merv Perry – Technician



Gene Davidson – Physicist
(also responsible for Beam
Acceptance Testing)



Stewart Pullen – Grad. Engineer
Contractor Apr07-Dec08

5 Tesla High Temperature Horizontal Magnet for SANS and Reflectometry

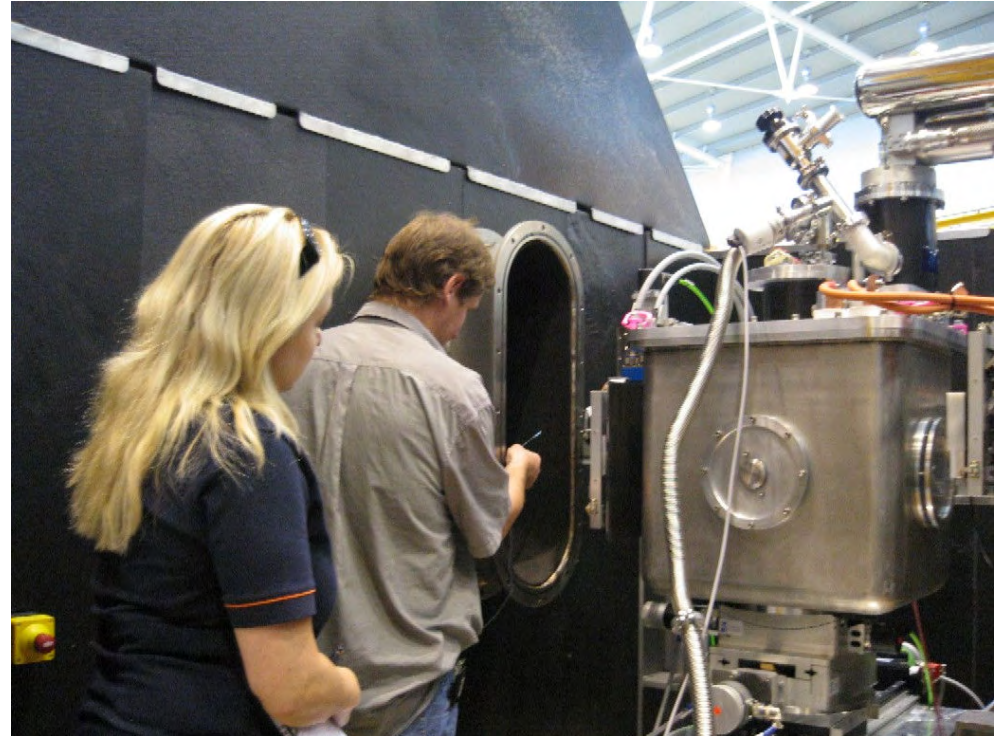
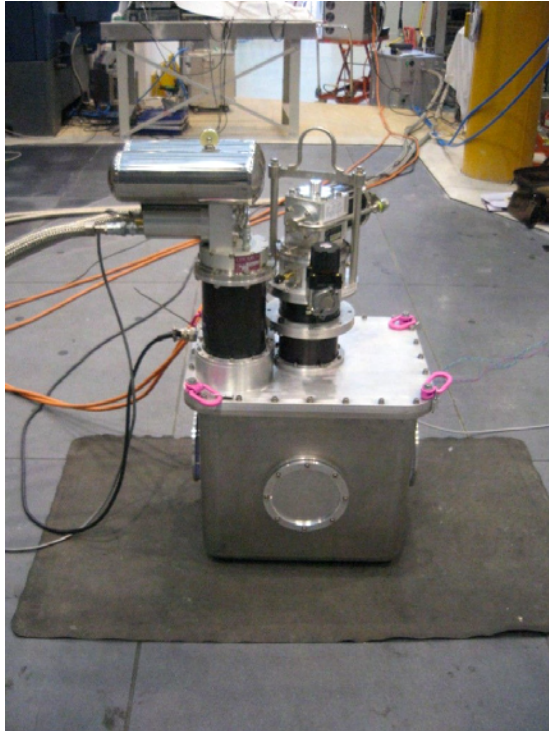

- Arrived Dec 2007
- Cool down time (to 20K) 48 hrs with Cryomech PT-810.
- Mounts on a goniometer to allow the magnet to be tilted in line or perpendicular to the beam.
- Slit motors located close to the beam damaged by the stray fields (which were within spec). Problems not foreseen.

5 Tesla Horizontal magnet con't.

- High temperature BSCCO material
- Large coil separation – both vertical and horizontal
- Operates at 20K with a pulse-tube cryocooler.
- Sample mounts in a Janis SHI-4 cryofurnace.

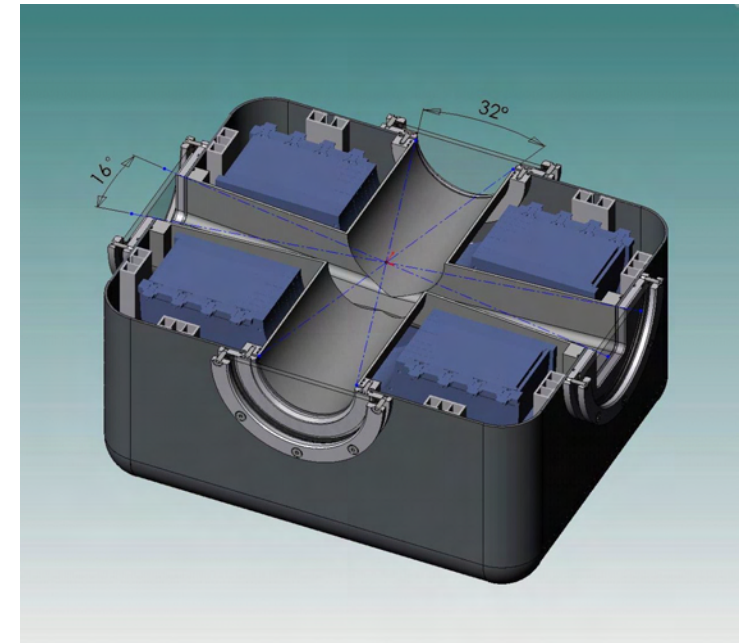
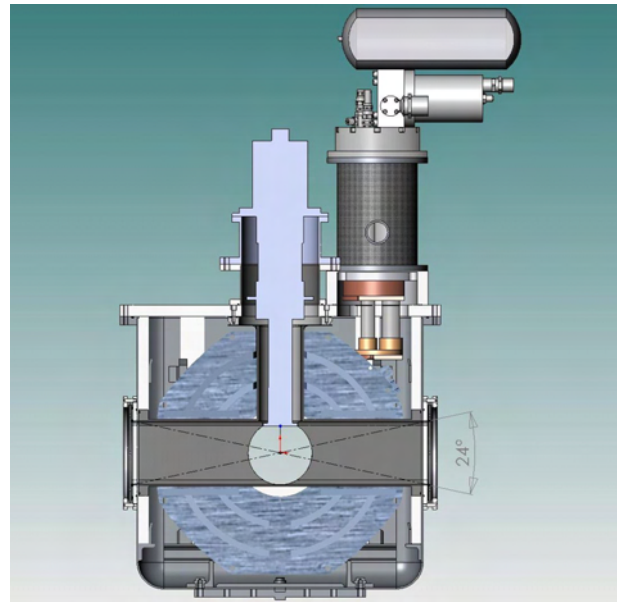

Transverse field profile

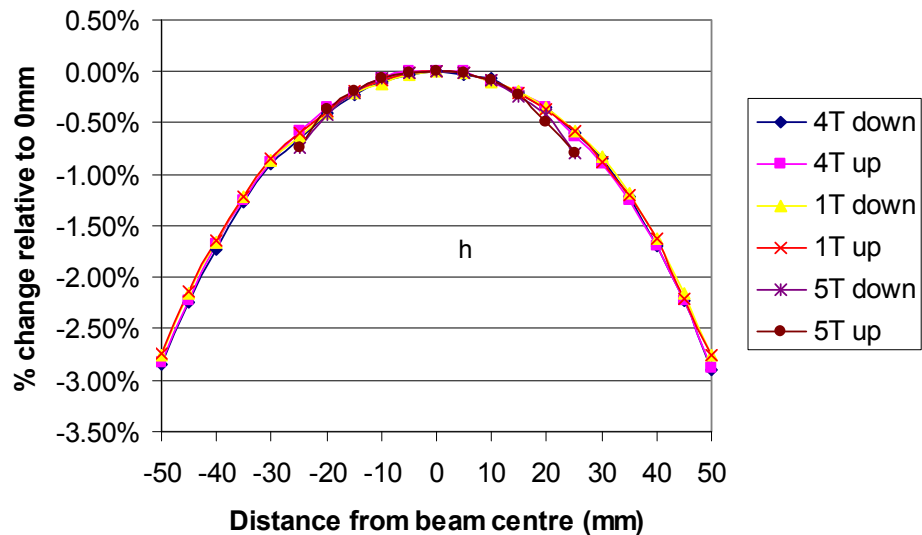

Axial field distribution

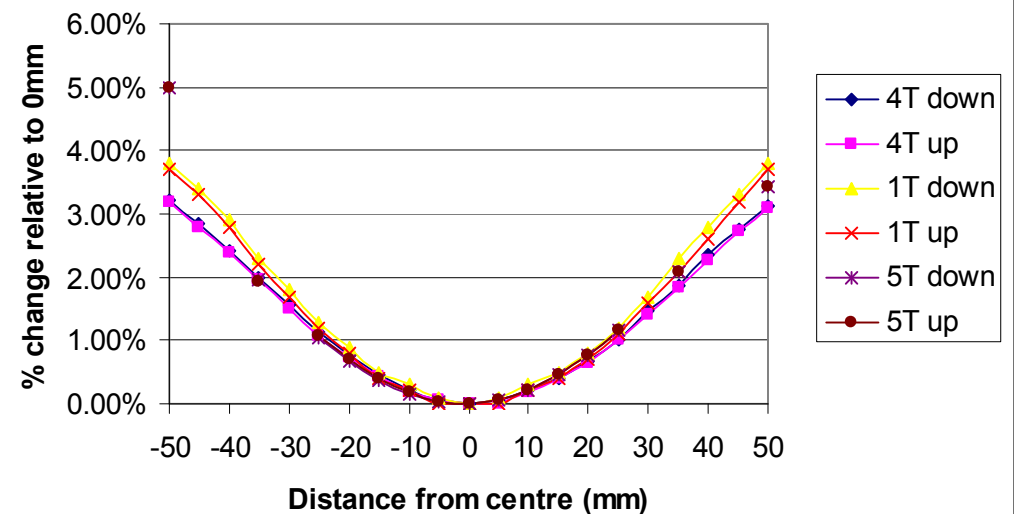



Carbon fibre beam tube

Stray Fields at 5 Tesla (from the windows)

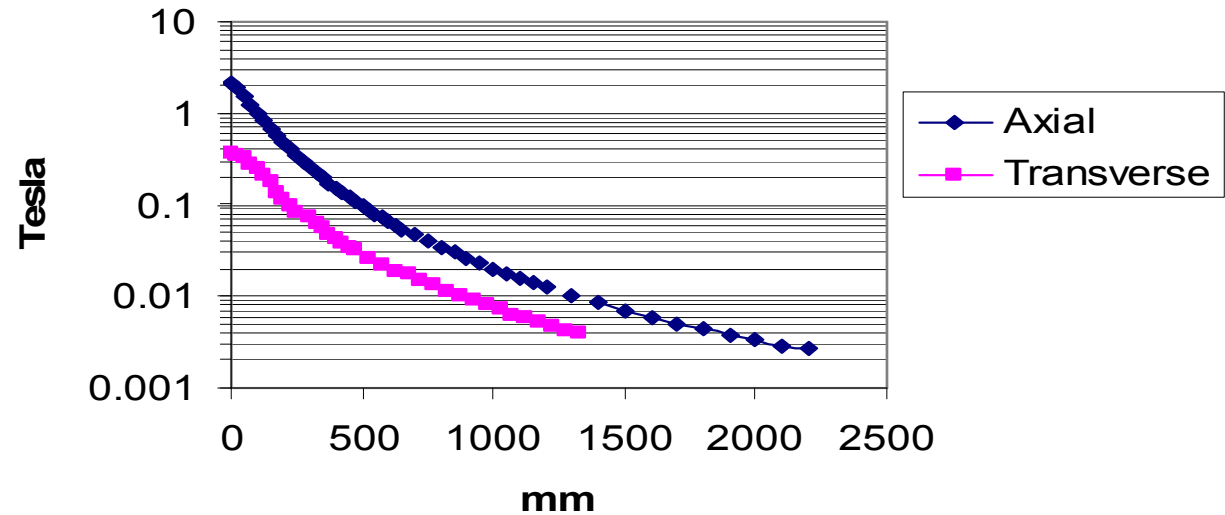

- Planned studies include: Spintronics - Magnetic nano-particles - Spin valves and magnetic recording structures - High-T_c/strongly correlated electronics materials - Conventional magnetic materials - Flux lattices in high T_c and conventional superconductors.
- Changes will be required prior to entering the user program - slit motors and encoders – which were not originally specified for magnetic immunity.
- Also requires licensing by the government regulator due to the stray fields exceeding ICNIRP 94 limits.

Rapid Heat Quench Cell for SANS

- Sample heating and cooling from 150K up to 640K at $> 15\text{K/sec}$ (sample dependent).
- The Cell is mounted on a translation stage to allow the beam to align on either the cold or hot cell.
- The sample is pneumatically moved between cells, held in Hellma Quartz cell.
- Cells heated and cooled by N_2 gas.
- Multiple jumps are possible, with the temperatures variable each time.
- Controlled by a LakeShore 340.

Indium Sample, New Nicrome Wire 1 May.

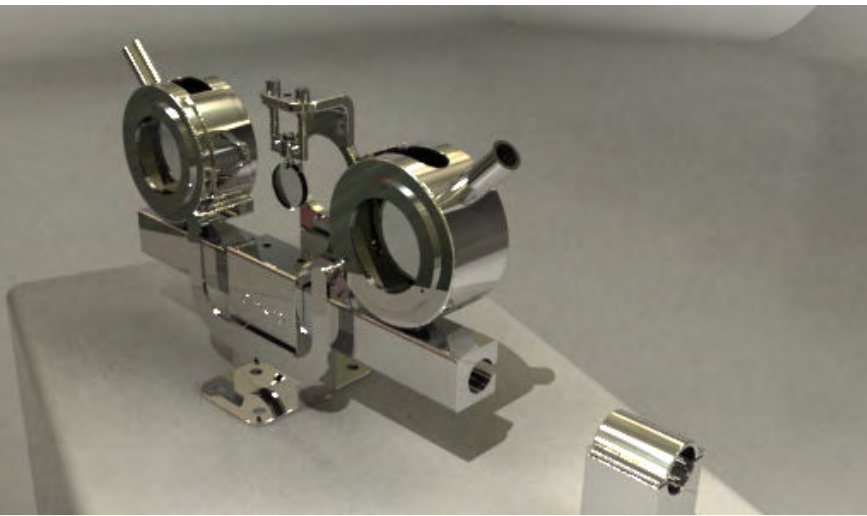
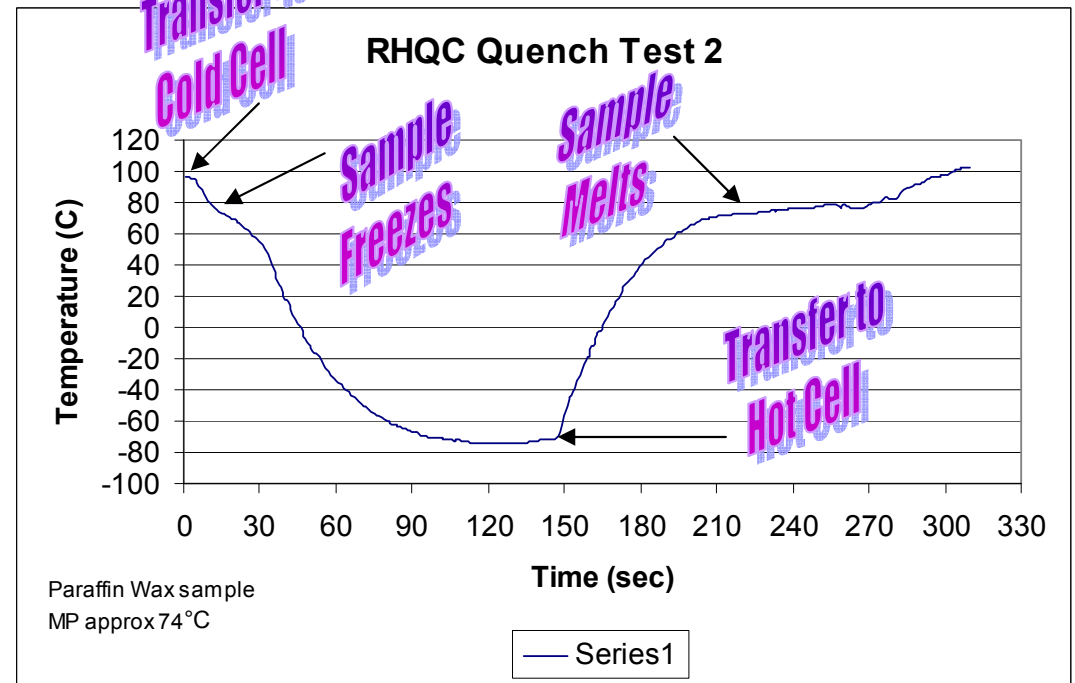
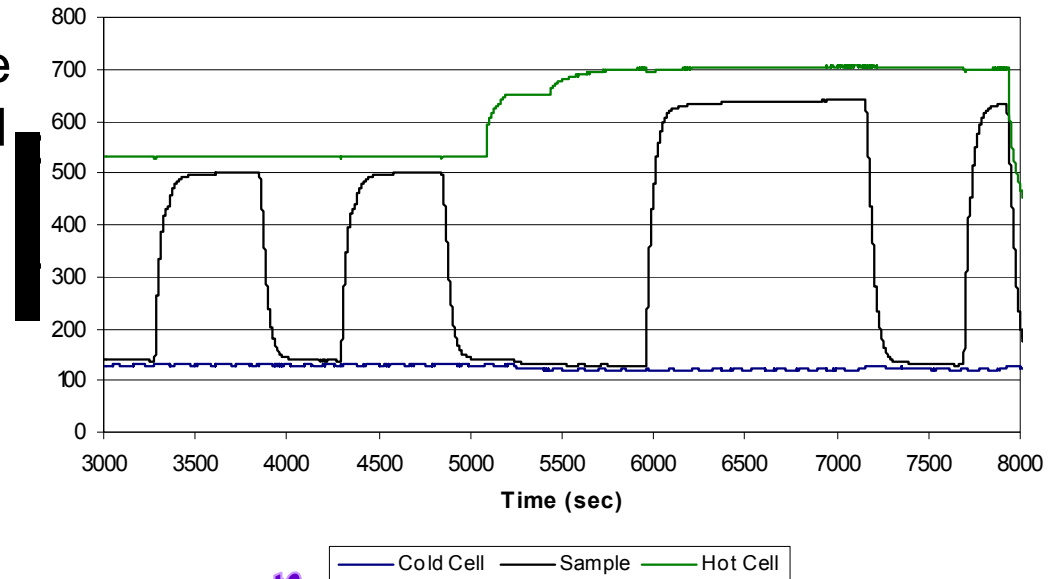

First SANS result for Paraffin Sample – at IPNS Sep 07

$$Q(t) = \pi DLh_m(t)(T_\infty - T_{QA}(t))$$

$$h_m(t) = \frac{k}{D} (0.4 \text{Re}^{1/2} + 0.06 \text{Re}^{2/3}) \text{Pr}^{0.4} \left(\frac{T_\infty}{T_{QA}(t)} \right)^{1/4}$$

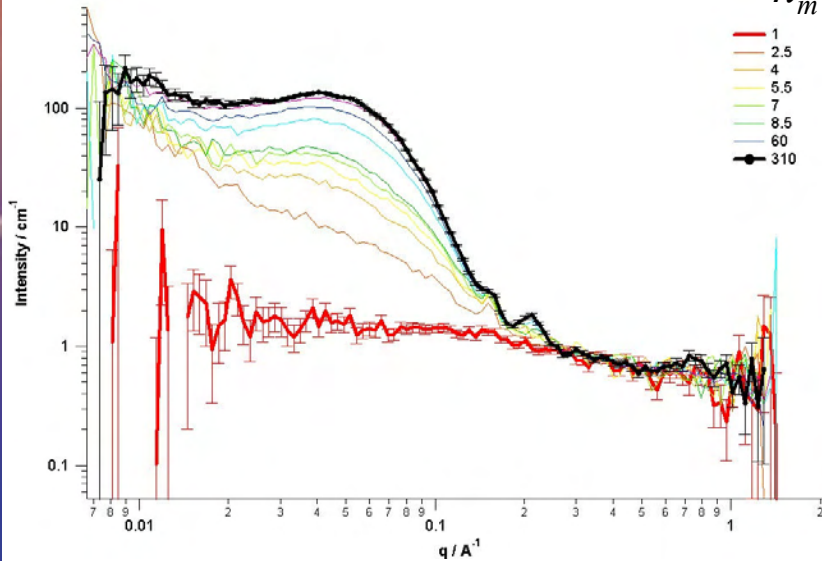

Using equations for heat transfer by forced convection across circular cylinders we modelled the system, the results matched quite closely with the obtained values, except for phase changes.

S Pullen *et al* 2008 'An in-situ rapid heat-quench cell for small-angle neutron scattering' Meas.Sci.Technol. **19** 065707. <http://stacks.iop.org/0957-0233/19/065707>.

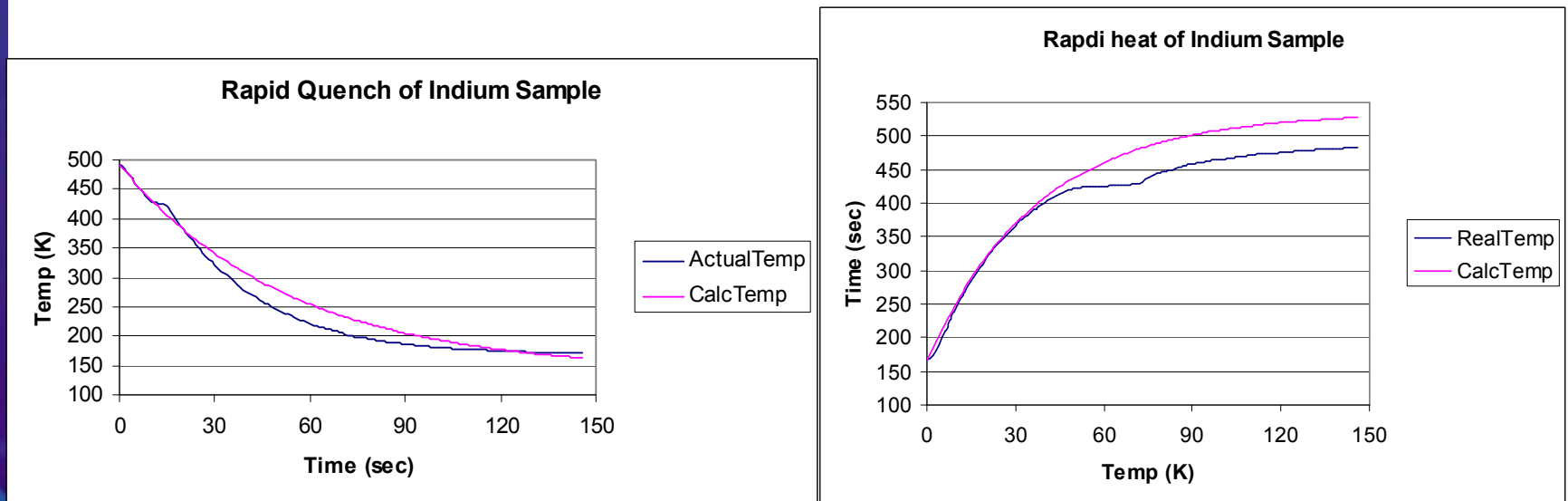

Video of testing at IPNS

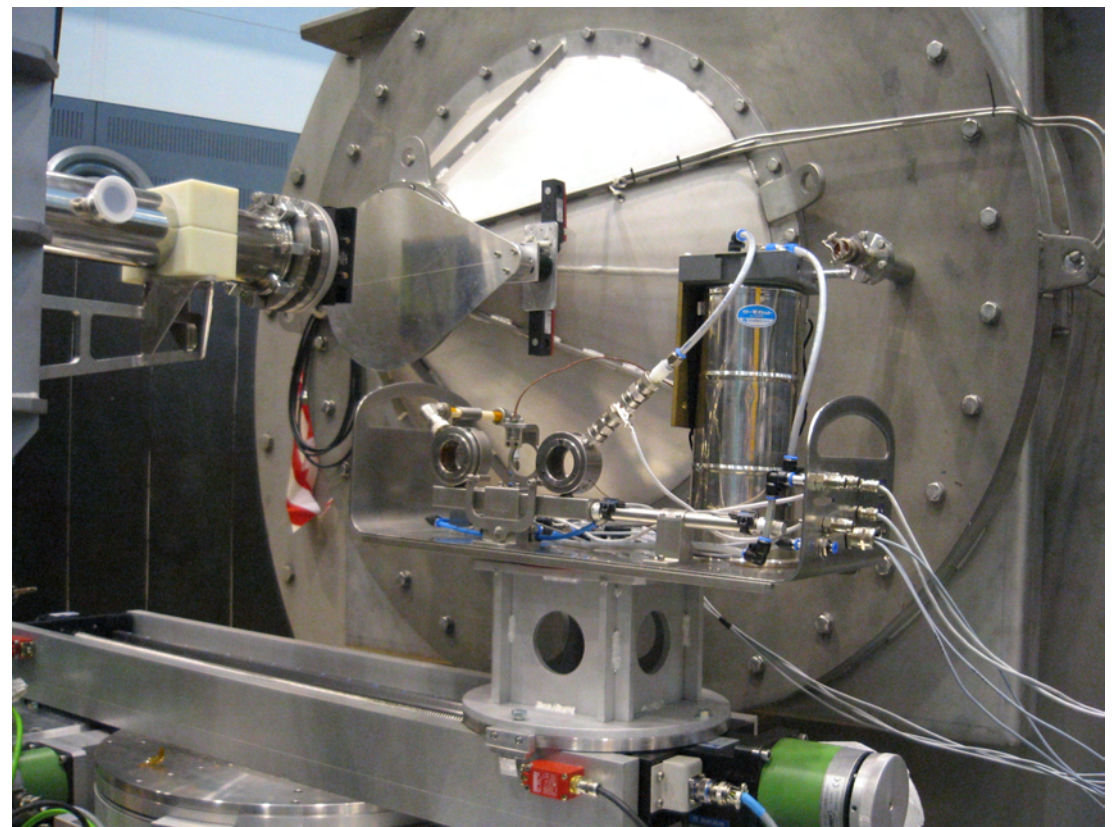
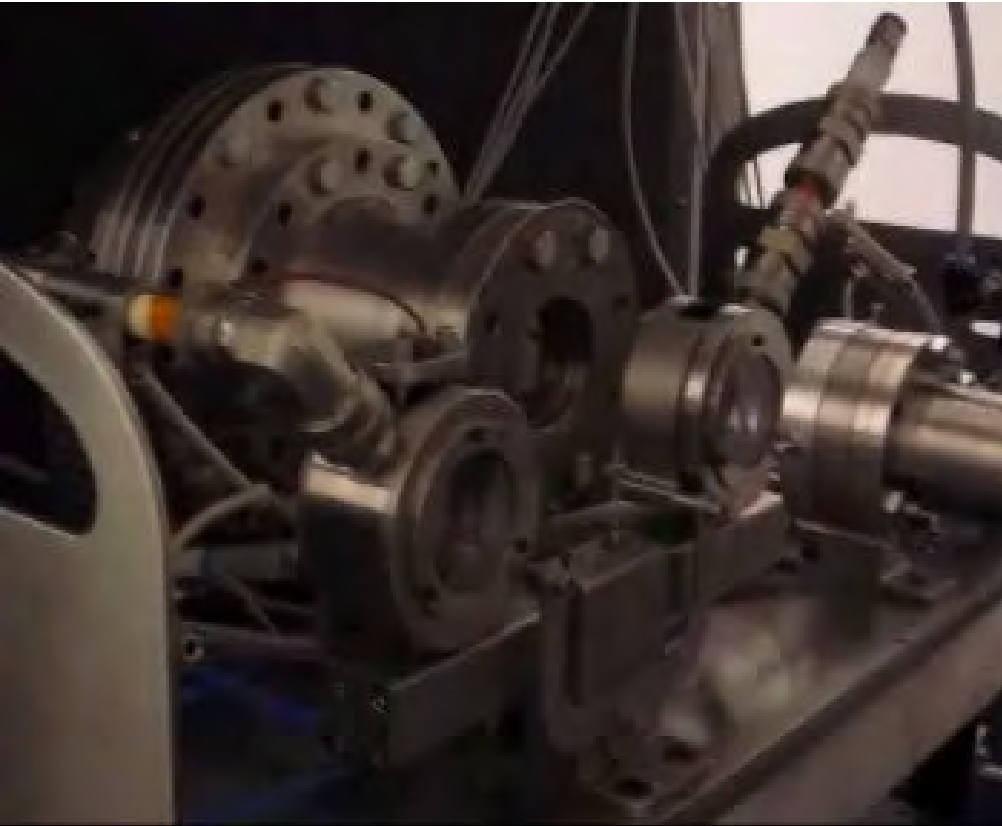

- Currently increasing power supply from 540W to 1000W, target sample max. temp. increase from 640K to 770K.
- Designing a new Aluminium cuvette to increase thermal conduction to the sample and thus increase ramp rates.
- A design modification is under way for use on SAXS machines.

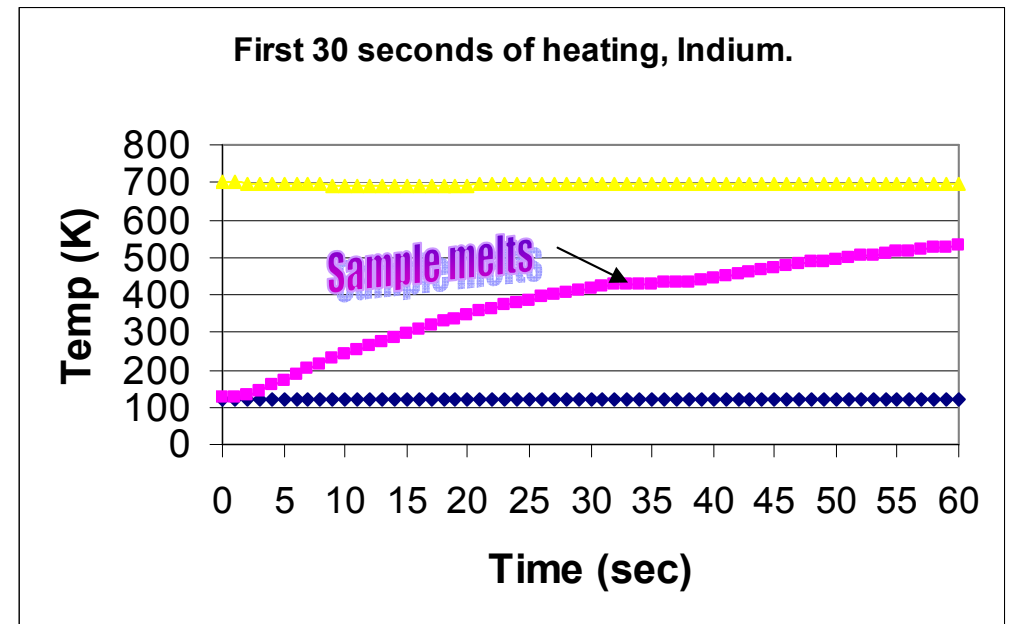



Australian Government

Ansto

11 Tesla Horizontal Magnet for SANS

- Tender open until June 18.
- Wet or dry Magnet
- Looking for +/- 30 degrees horizontal access ports.
- VTI to cool sample to 1.4K
- We expect to purchase a ^3He One Shot Fridge next year.

Stopped Flow Mixing Cell

- Bio-Logic SFM-300 (3-syringe) Stopped Flow System due Aug 08.
- The equipment will enable the mixing of small volumes of solutions (down to 0.01mL) in a very short time (10-90 ms) with an excellent reproducibility.
- Similar to the one on D22 at the ILL



Australian Government

Ansto

Sample Changers for SANS

- Based on NIST designs.
- 20 position -20C to 100C controlled via a Julabo LH45 water bath.
- 10 position +20C to 350C using 4 Watlow 2000W heater cartridges (out to tender). Gas cooled.
- Nitrogen blanket on the front and back to reduce condensation (steel tubes with 1mm holes every 20mm).

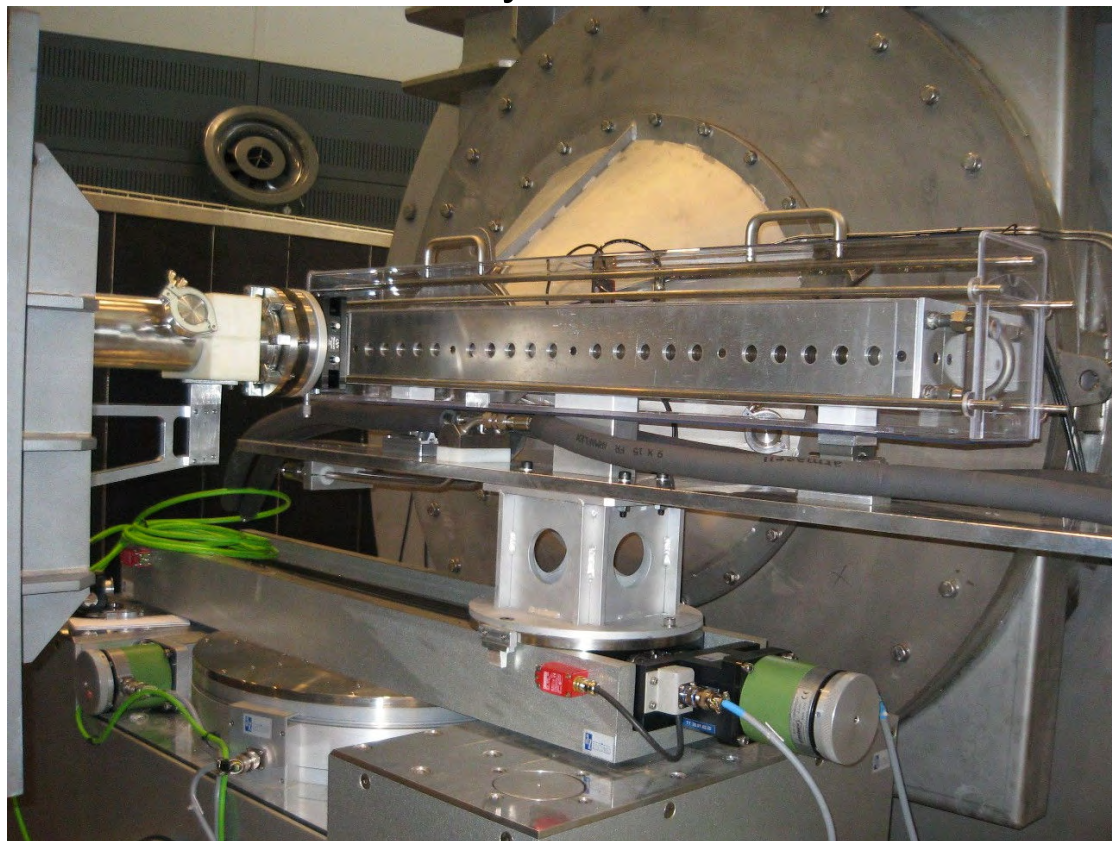

ANCILLARIES
STRATEGIC
PLAN



Australian Government

Ansto

Robotic Sample Changer

- A 4 axis robot to pick and place samples (eg Vanadium cans) from a tray and place them in the beam.
- Will be remotely controlled from the instrument cabins.
- Can rotate the sample in the beam.
- If required can translate (vertically) in the beam.



ANCILLARIES
STRATEGIC
PLAN

Robotic Sample Changer tray and lid

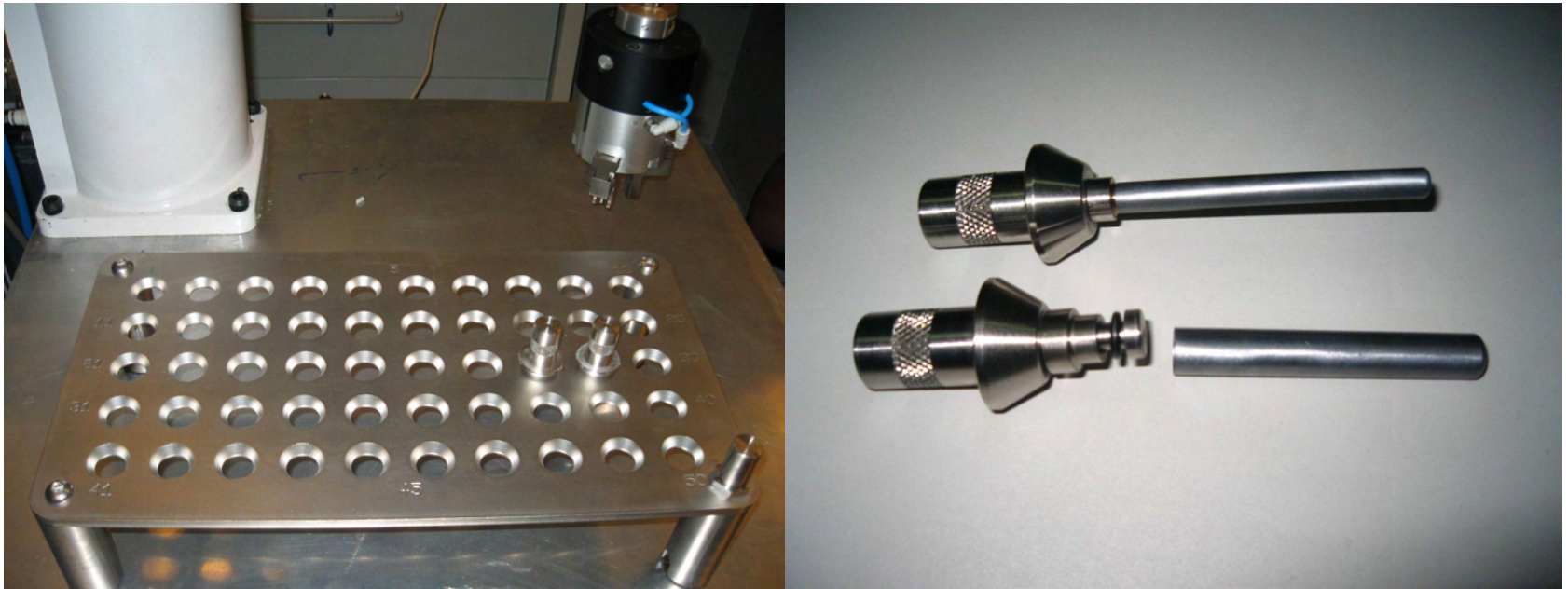

- O-ring sealed lids for the Vanadium Cans.
- Designed for either robotic pick up and knurled design for ease of human use.
- Either $\frac{3}{8}$ " or $\frac{1}{4}$ " Vanadium cans fit into the tray.
- Can mount two trays (50 samples per tray) at once, either for 100 samples or to isolate samples that have been irradiated.

H₂/D₂/CH₄ Gas Rig - rated to 124 bar

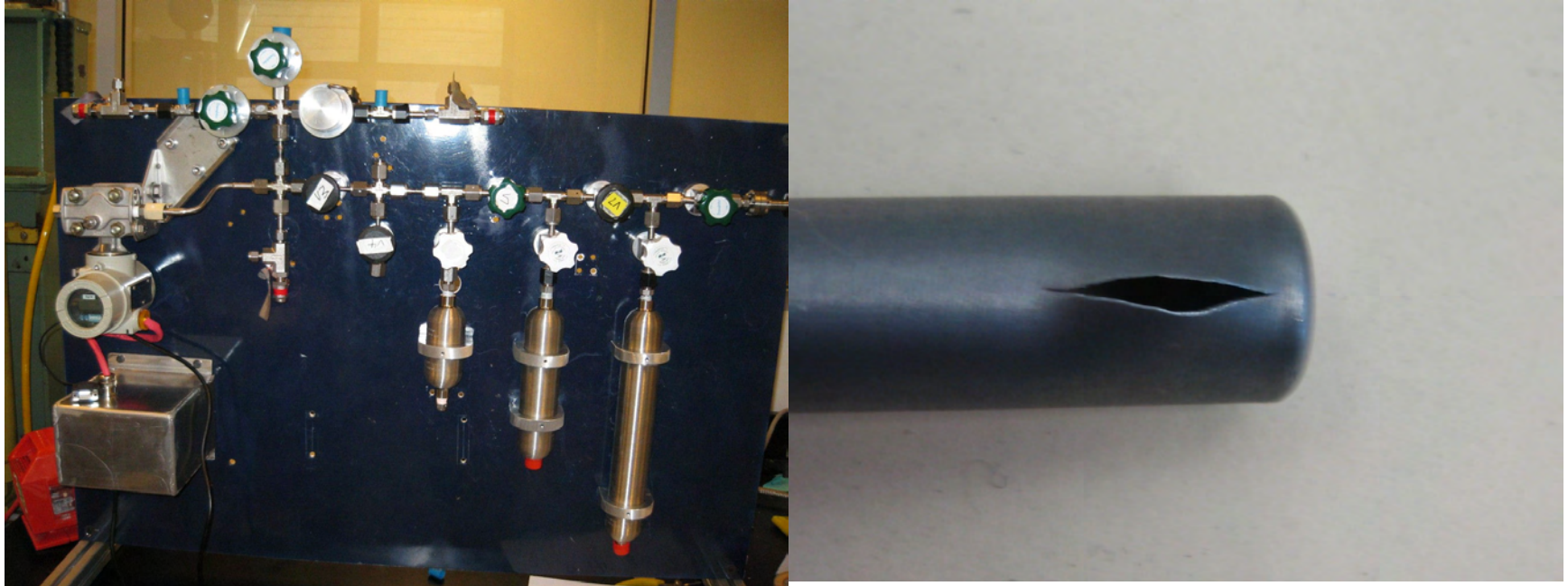

Pressure tests on Vanadium Cans. 15bar (3/8") and 30bar (1/4").

- Based on NIST design (T Yildirim, C Brown & J Leao).
- Plan to build a 1000 bar rated rig in the next year.
- Also want to look into automating the valves.
- Samples can be in an Orange Cryostat or Closed-cycle system.

100kN load frame & furnace

- Very similar to the one on Engin-X at ISIS, 50mm displacement.
- A 1200C air furnace (ISIS design) is under fabrication with help from Ed Oliver & Zoe Bowden.
- Capable of fatigue testing – with a trolley to allow for ex-situ testing.
- Plans for an environmental chamber, though there is little user demand for this at the present.



A Controlled Atmosphere Furnace – the Insitu reaction chamber (ISRC)

- Consists of a standard outer box with user specified inner box.
- Initially set up for experiments on oxide ceramic processing. Other inner box designs for experiments on adsorption and rapid heating.
- Under construction due late this year.
- Can operate in flow through or vacuum mode.
- Designed by Daniel Riley (UniMelb) and Erich Kisi (UniNewc) based on work on D20 at the ILL with Alan Hewat, Thomas Hansen and Paul Henry.
- Initially designed for powder diffraction, additional chambers will be fabricated next year for SANS and triple axis.

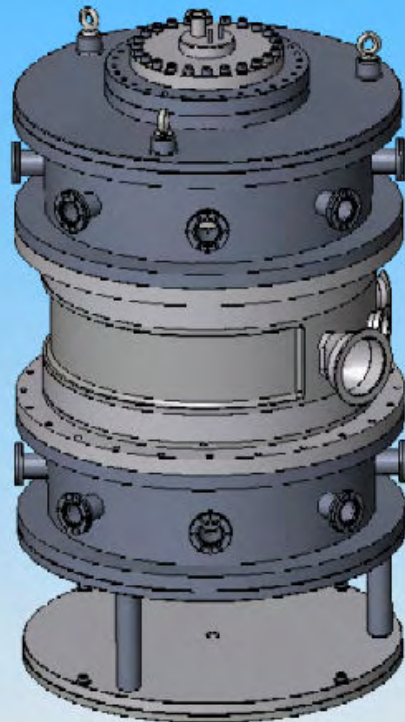

←

- ISRC outer vacuum chamber (640mm diameter, 917mm high)

- Experiment specific insert.

→

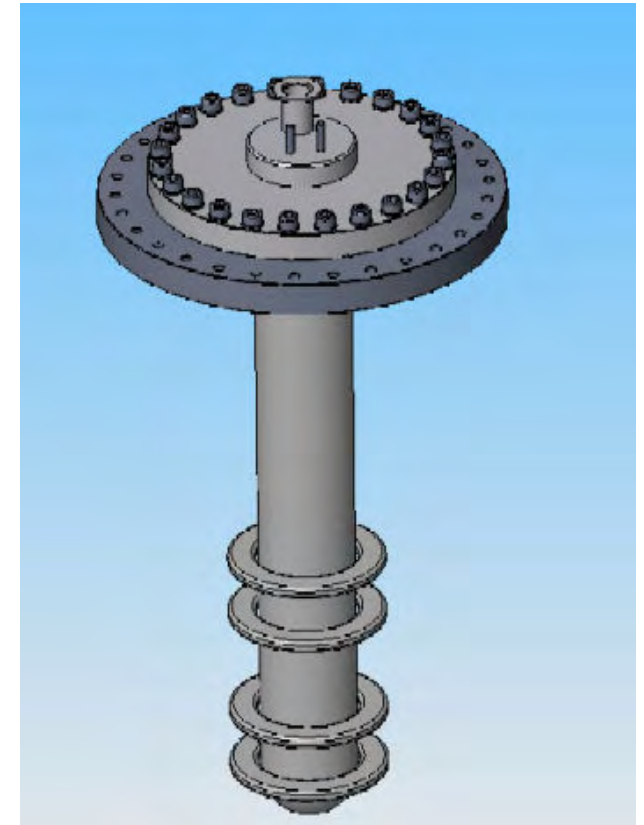



Australian Government

Ansto

5 Sample Liquid Air Trough

- Based on ISIS designs from Stephen Holt & Dennis Cowdrey.
- Peltier cells for heating and cooling, challenges in testing.
- Designs on hold at the moment.



**ANCILLARIES
STRATEGIC
PLAN**



Australian Government

Ansto

Paris-Edinburgh High Pressure Cell

- Testing of 130 Tonne VX-5 PE Cell next week in Paris.
- Reviewing options for low temperature operation.
- Automatic control system being designed in house.
- A double compressor system (rated for hydrogen) from Nova Swiss has been ordered. A 1000bar compressor, to be used both on a high pressure hydrogen gas loading system, and as an input to the 3000 bar system for the PE Cell.

AC Impedance Spectroscopy Cell

- *Electrical impedance spectroscopy (EIS)* - used to study the structural & electrical properties of biomembranes as well as organic-silicon nanocomposites.
- Due this month.
- Purchased from Inphaze – a local Sydney company
- Impedance range of 0.1 to $10^{10} \Omega$.
- Phase precision of 0.001°
- Impedance precision of 0.002%

ANCILLARIES

STRATEGIC

PLAN

Summary

- User program was expected to start Aug 07, now likely Aug 08
- Reactor operational after long shutdown.
- First in-house designed Sample Environments delivered.
- Continued work on remote control of sample environment via SICS is required.
- Selection of Graphical User Interface & data acquisition system.
- A number of new purchases expected before the end of 2008.
- We need advanced warning on any user supplied Sample Environment due to a stringent safety system. (eg certificates for pressure vessels, lifting equipment or they will be tested in house).
- Contact with sample environment staff at institutes in the Asia/Pacific region has not progressed far.
- 3 staff from NESCA (South Africa) due for 1 month in August, 2 will join the computing group and one sample environment.
- We hope to host this workshop sometime in the future!